

Možne izdelave oken glede na obliko:

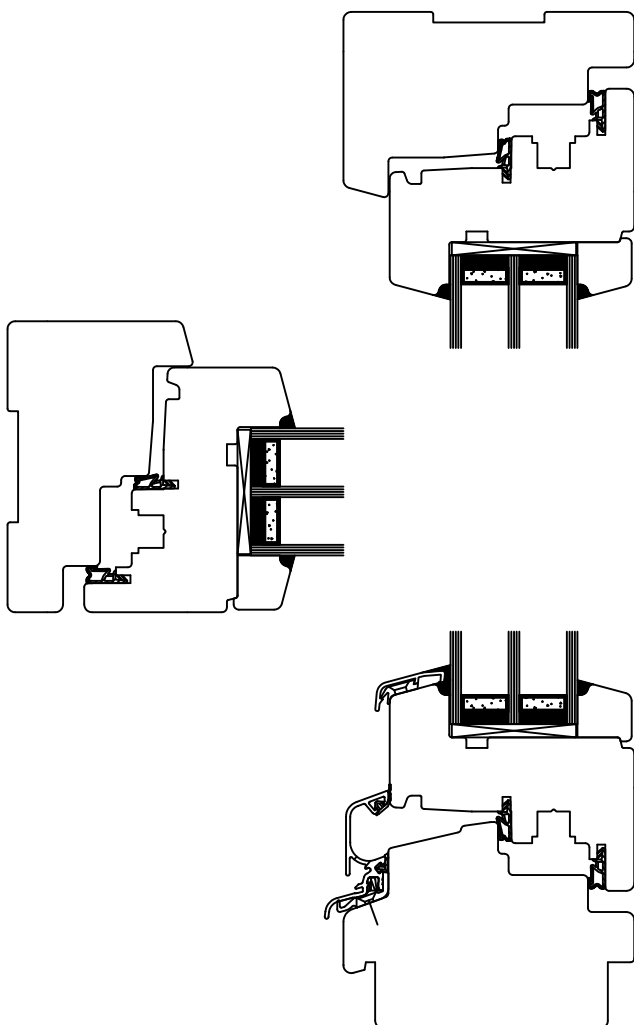
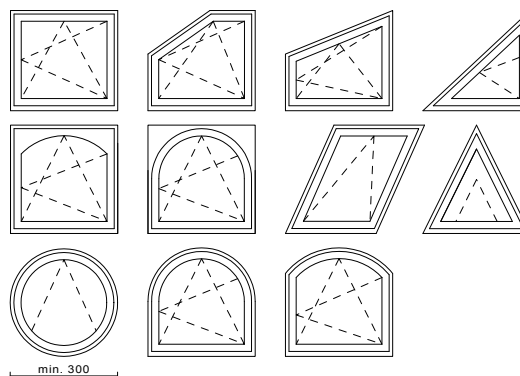

Tehnični podatki:

Okno iz lesa

Odpiranje po vertikalni in horizontalni osi

Odpornost proti obremenitvam z vetrom: Razred 5

Vodotesnost: Razred E1200

Toplotna prehodnost stekla - Ug: 0,5 W/m²K

Toplotna prehodnost okna - Uw: 0,72 W/m²K

Toplotna prehodnost okvirja - Uf: 0,92 W/m²K, Uf.sp: 0,99 W/m²K

Zvočna izoliranost okna: 33 dB

Prepustnost zraka: Razred 4

Vrsta lesa: smreka / jelka

Debelina krila: 92,5 mm

Debelina okvirja: 110 mm

Vidna širina okna: 107 mm

Steklo: 4:18Ar/4/18Ar/4 Ug = 0,5 W/m²K, Rw = 31 dB

Steklo: TGI termo distančnik - črne barve

Skupna debelina stekla: DK = 26 - 52 mm, FIX = 40 - 66 mm

Okovje: Roto NT - sive barve

Število tesnil: 2

Barva tesnila v krilu: siva, rjava

Silikon pri steklu: transparent

Površinska obdelava lesa: končna vodna lazura po barvni karti M SORA

Barva odkapnega profila na okvirju in krilu: siva EV1, rjava C33, bela RAL 9016

Opcije:

Toplotna prehodnost stekla - Ug: 0,6 W/m²K, 0,7 W/m²K

Toplotna prehodnost okna - Uw: 0,80 W/m²K, 0,87 W/m²K

Zvočna izoliranost okna: 33 - 39 dB

Vrsta lesa: macesen, hrast, red grandis, termo smreka

Steklo: 6:16/6/18/6, 8:14/8/14/8, 6:18/4/18/4, 8:18/4/18/4, 10:16/4/18/4,

33.2/18/4/18/4, 33.2/16/4/18/33.2, 44.1/18/4/18/4, 44.1/14/4/16/44.1, 55.2/16/4/18/4

Okovje: Roto NT Designo II, Roto NT PowerHinge

Število tesnil: 3

Barva tesnila: bela

Silikon pri steklu: bela, rjava, temno rjava

Barva odkapnega profila na okvirju in krilu: v barvi okna

Odkapni profil na okvirju: leseni

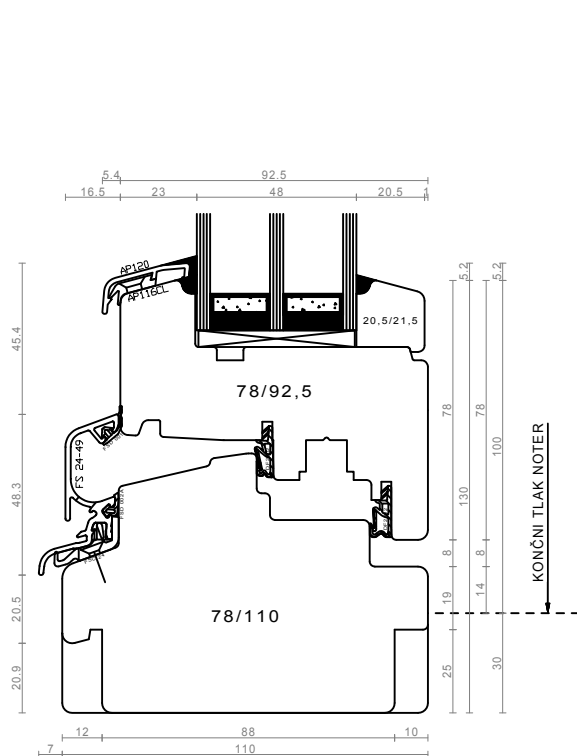

spodnji prečnik - okno in balkonska vrata

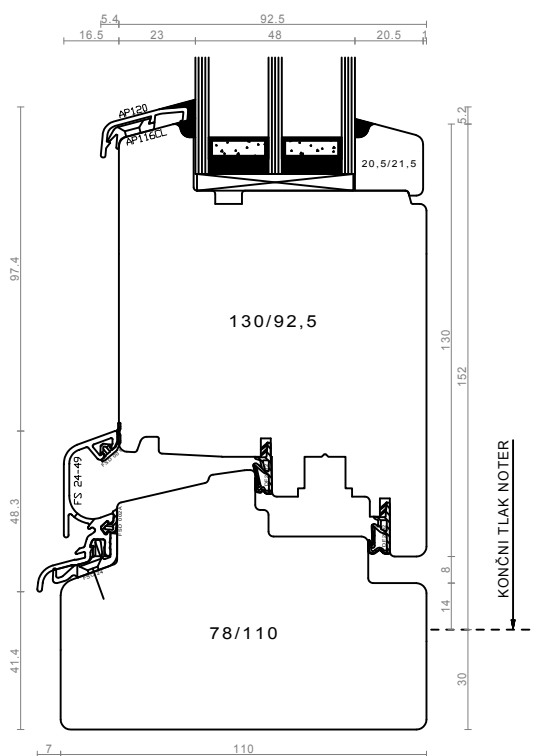

spodnji prečnik - balkonska vrata (razširano)

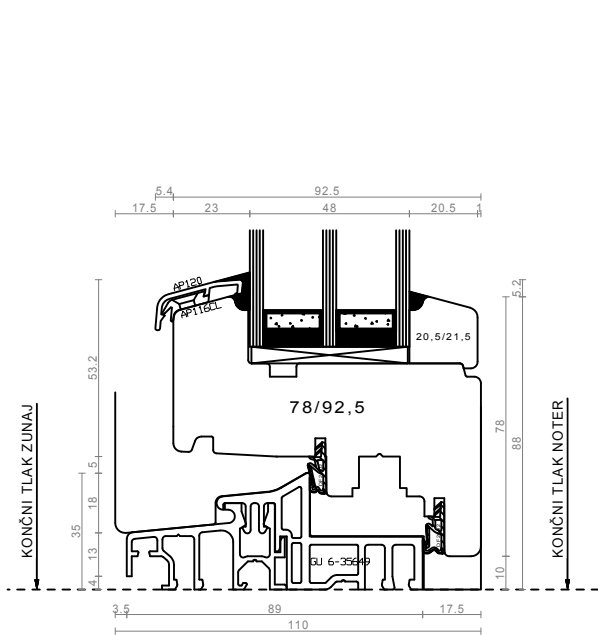

spodnji prečnik / pohodni profil - balkonska vrata

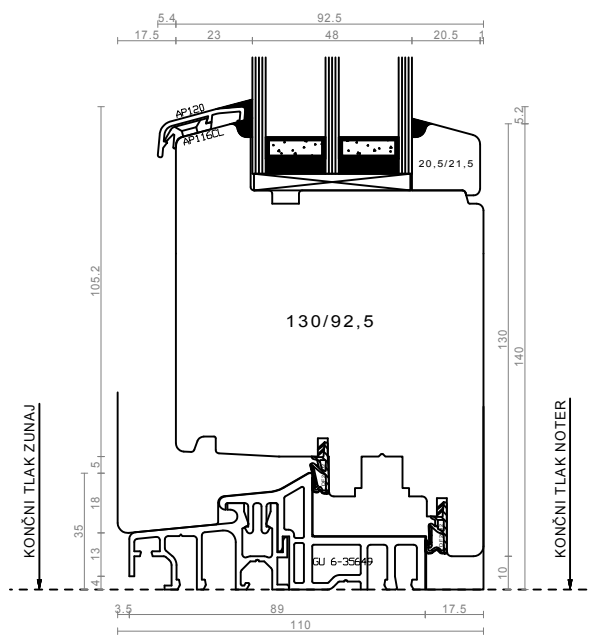

spodnji prečnik / pohodni profil - balkonska vrata (razširano)

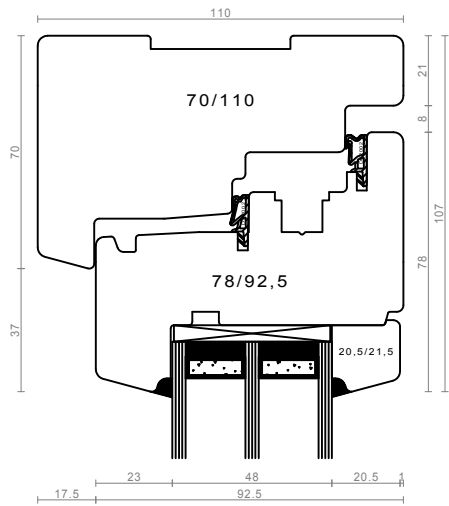

pokončnik in zgornji prečnik

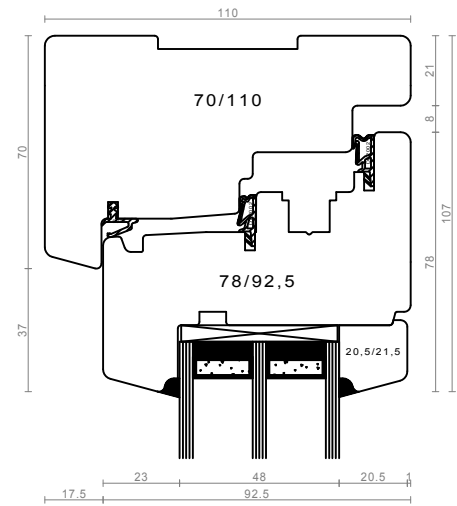

pokončnik in zgornji prečnik - tretje tesnilo

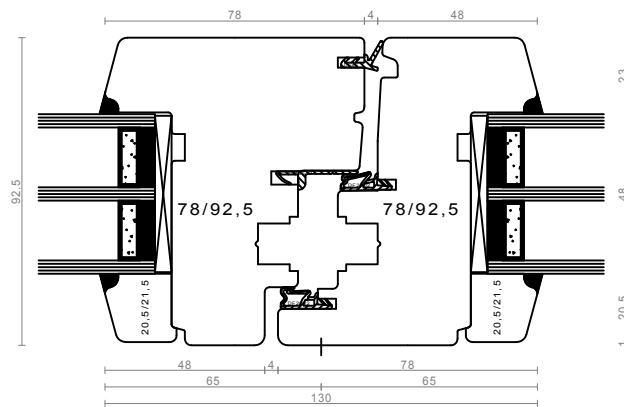

dvokrilno brez pokončnika - D/DK

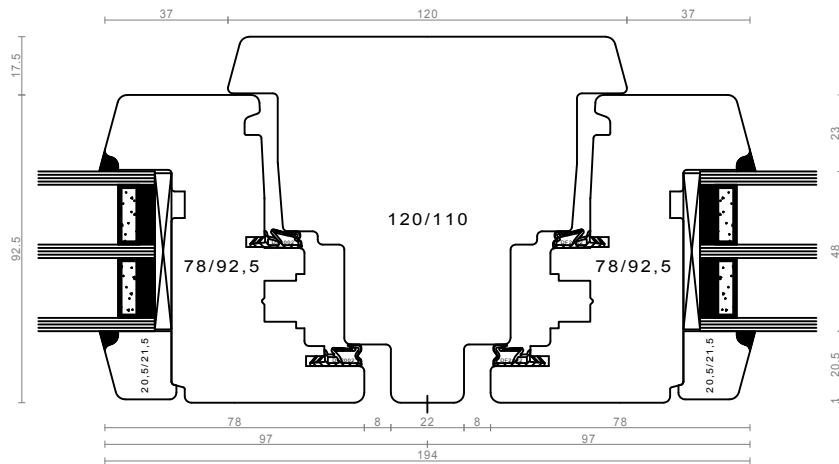

dvokrilno s pokončnikom - DK/DK

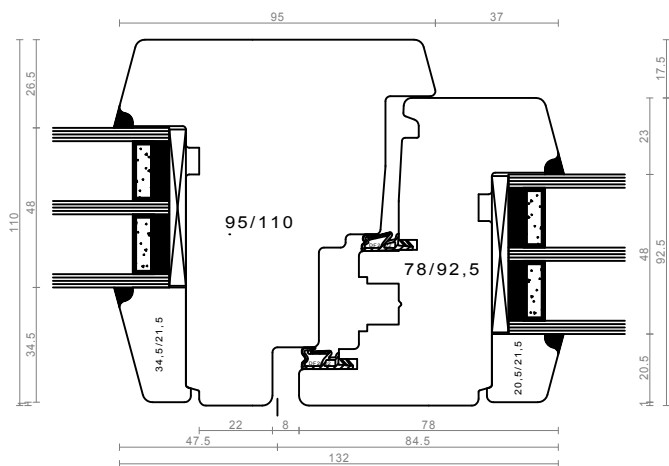

sredinski pokončnik - FIX/DK

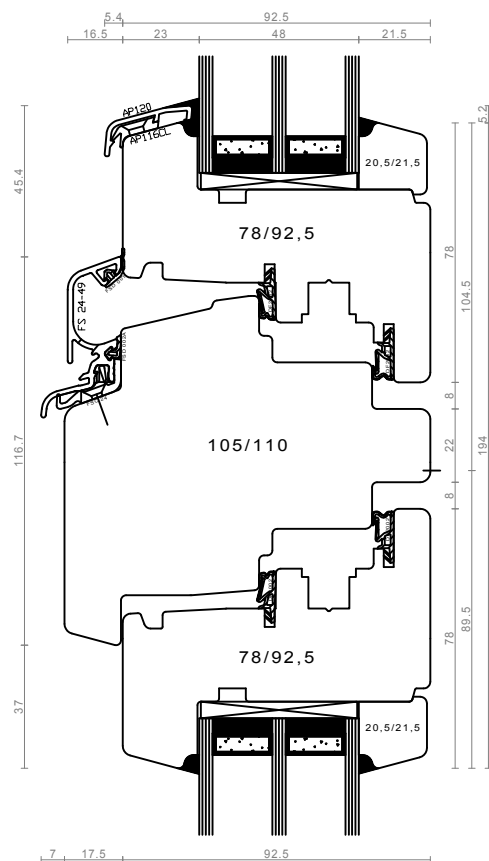

sredinski prečnik - KIP/DK

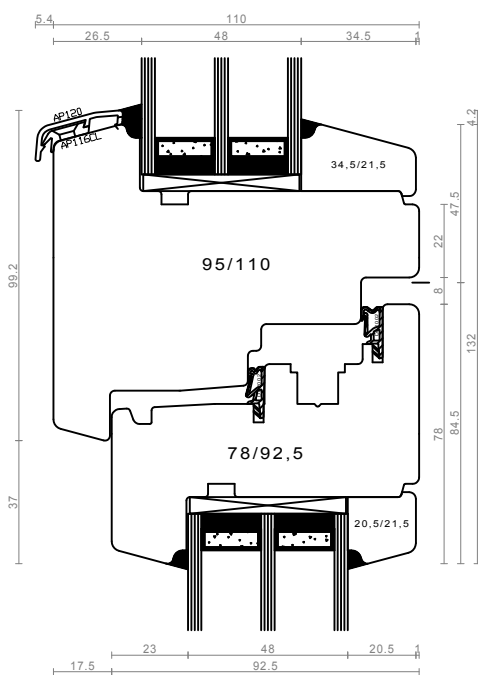

sredinski prečnik - FIX/DK

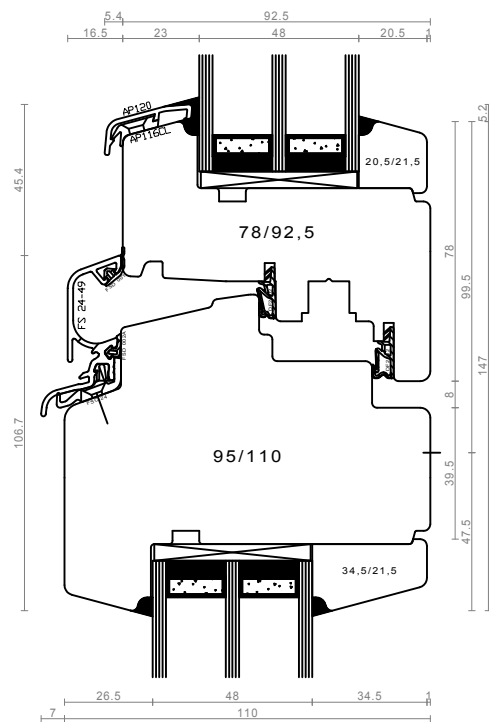

sredinski prečnik - DK/FIX

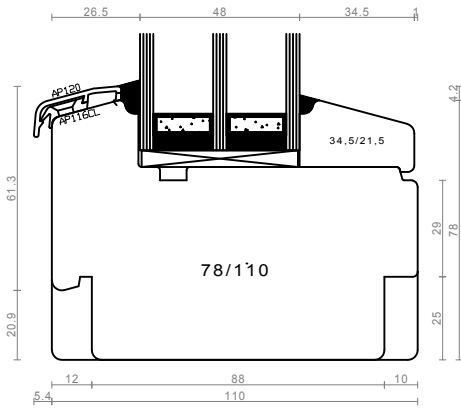

spodnji prečnik - fiksno okno

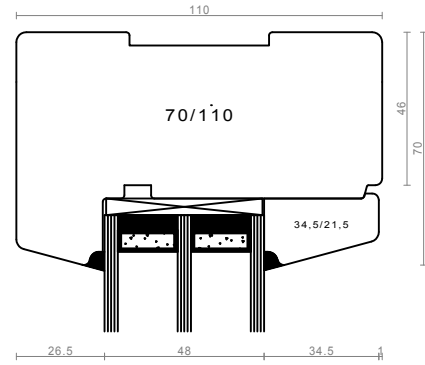

pokončnik in zgornji prečnik - fiksno okno

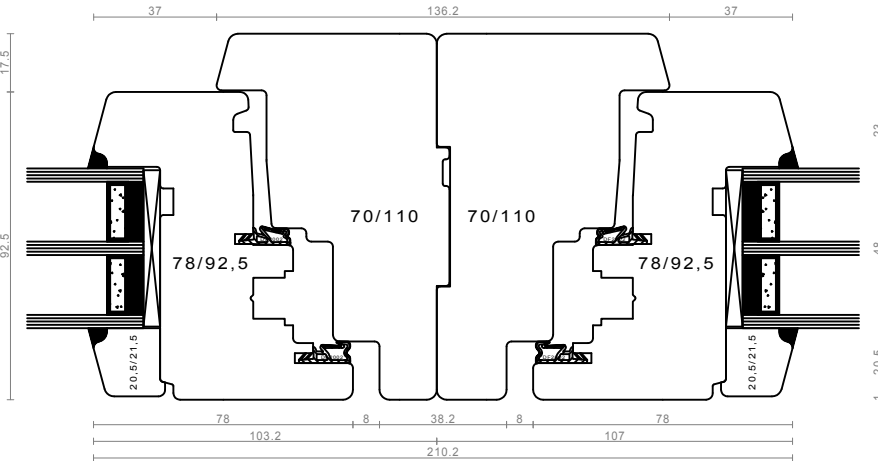

sestav po horizontali - DK/DK

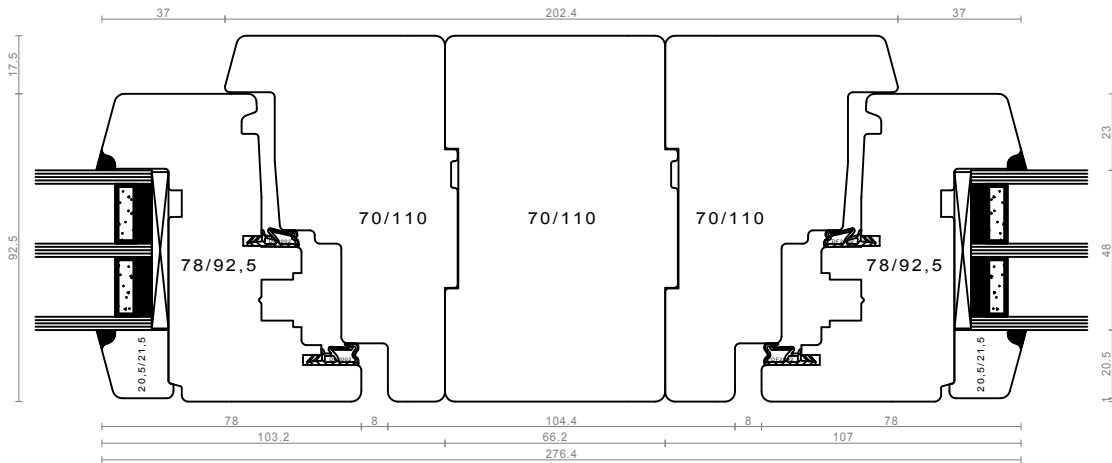

sestav po horizontali z vmesnim vložkom - DK/DK

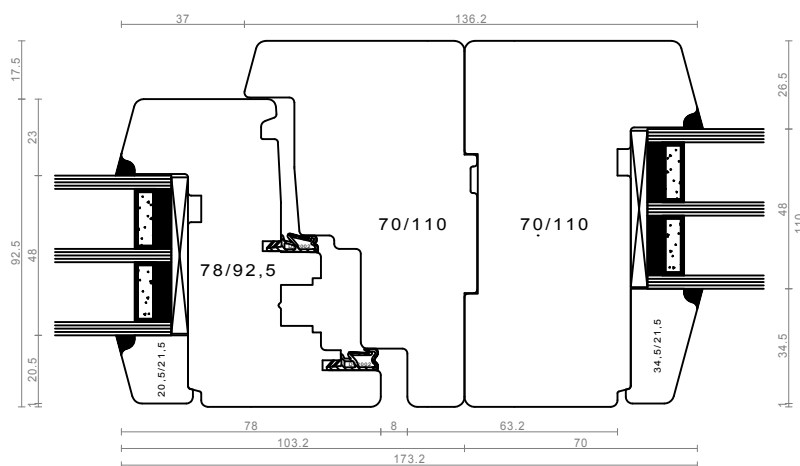

sestav po horizontali - DK/FIX

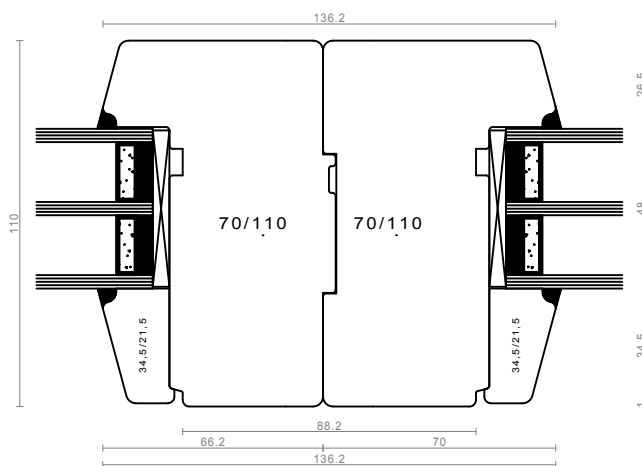

sestav po horizontali - FIX/FIX

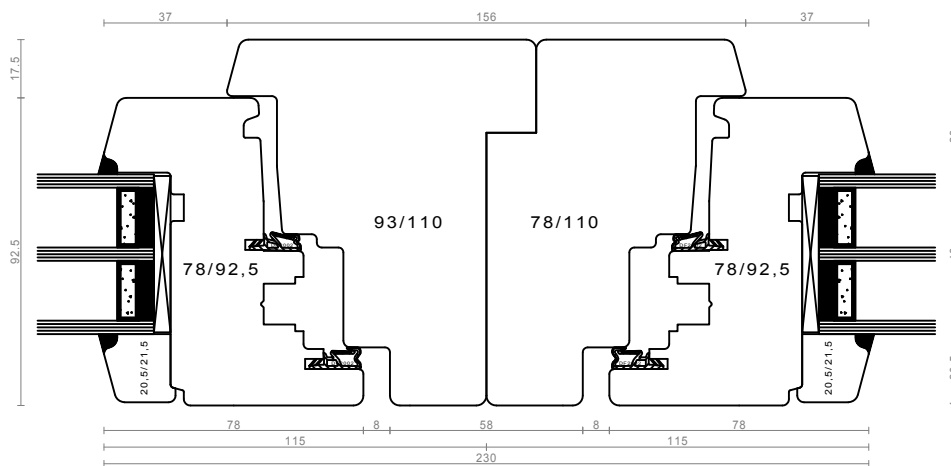

sestav po horizontali / slepi podboj - DK/DK

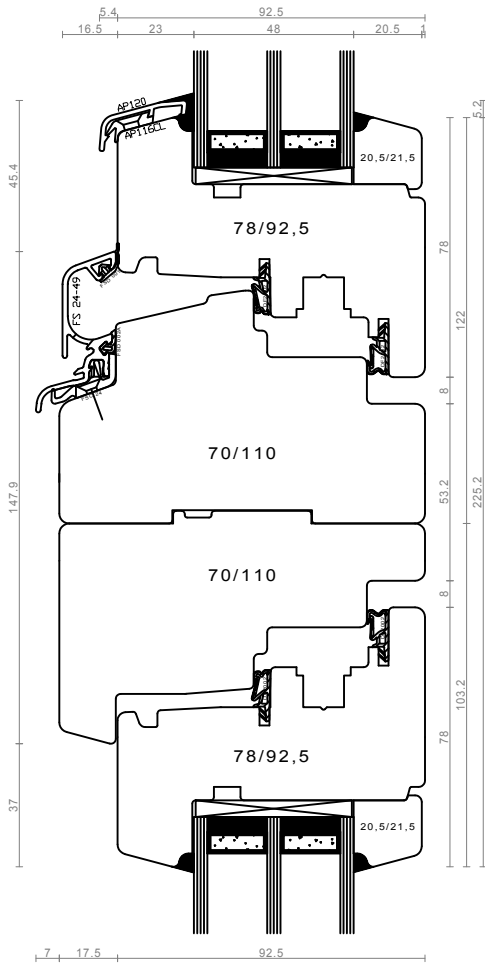

sestav po vertikali - DK/DK

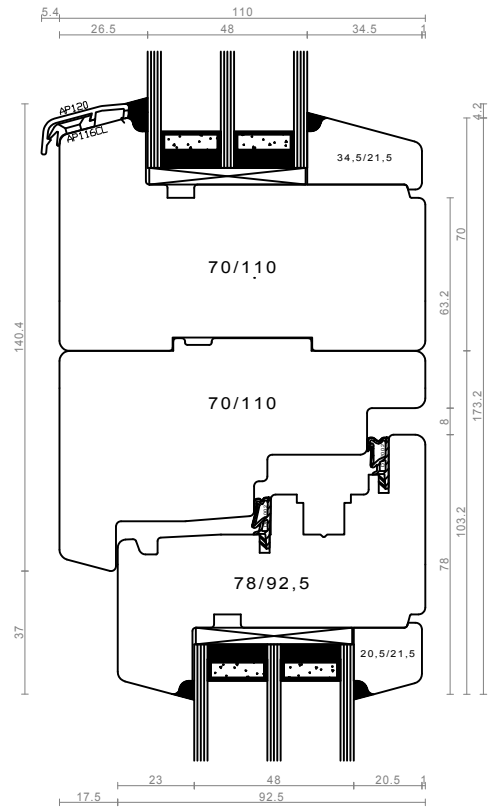

sestav po vertikali - FIX/DK

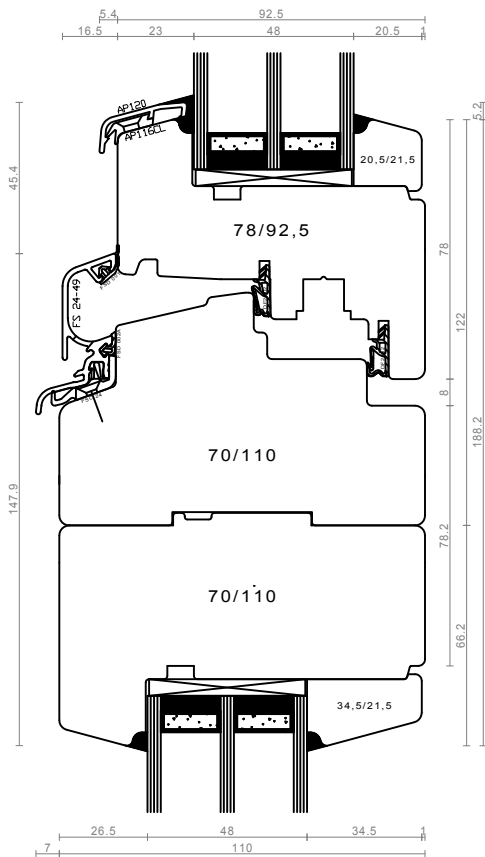

sestav po vertikali - DK/FIX

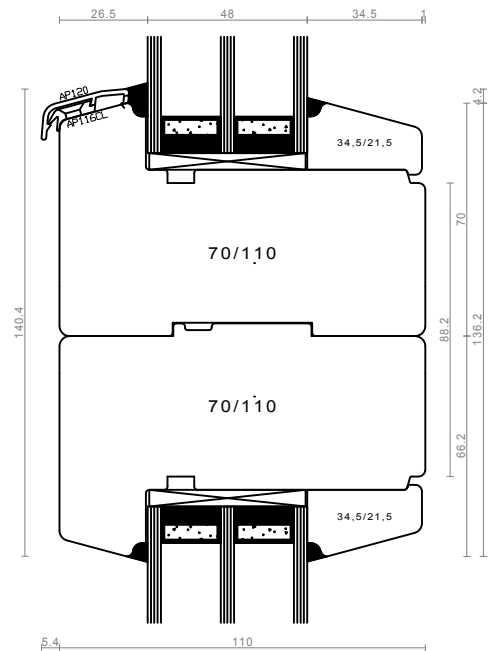

sestav po vertikali - FIX/FIX

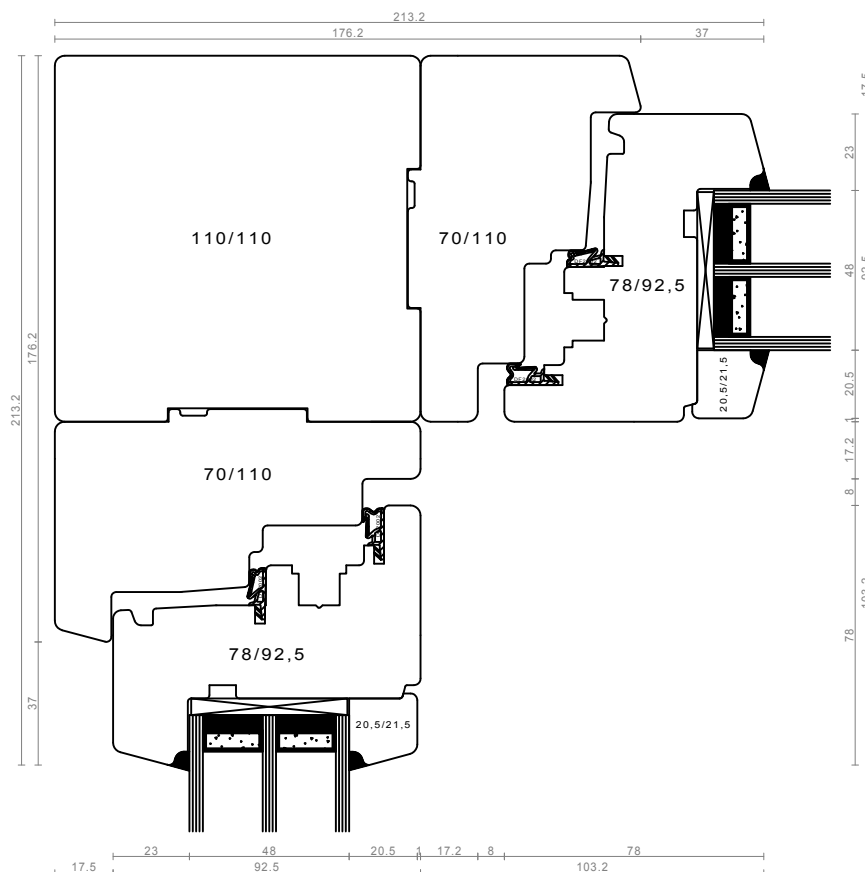

vogalni sestav - DK/DK

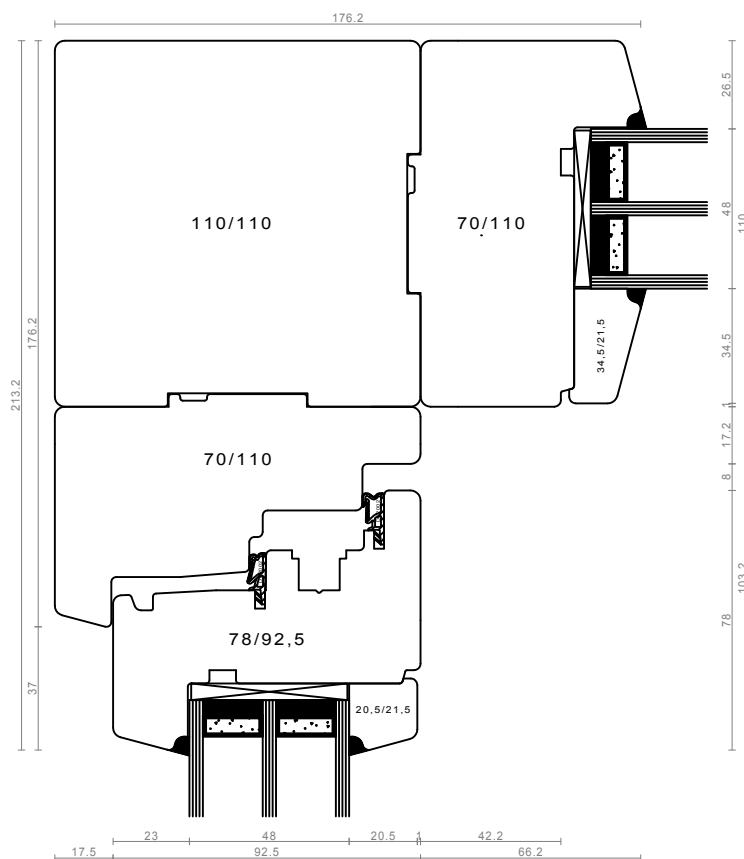

vogalni sestav - DK/FIX

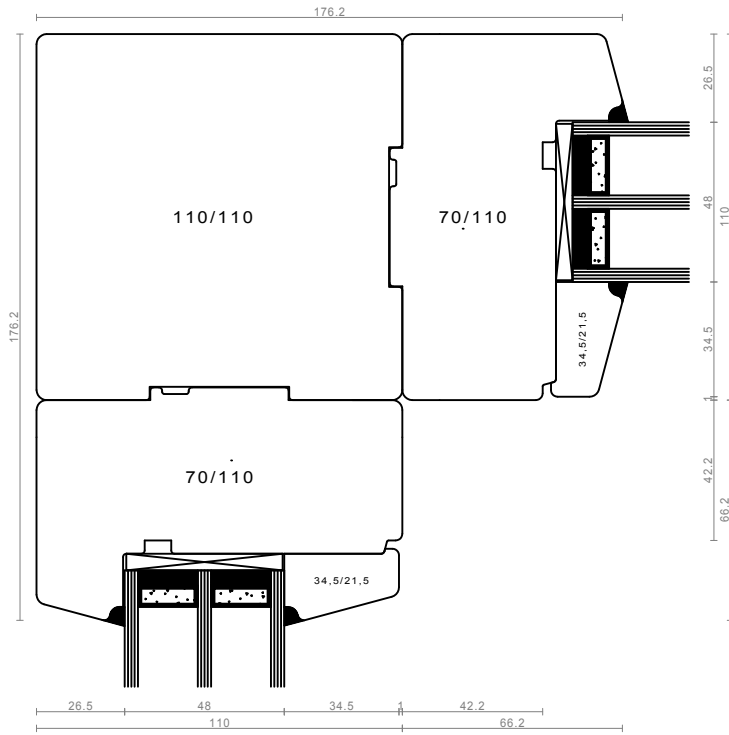

voglani sestav - FIX/FIX

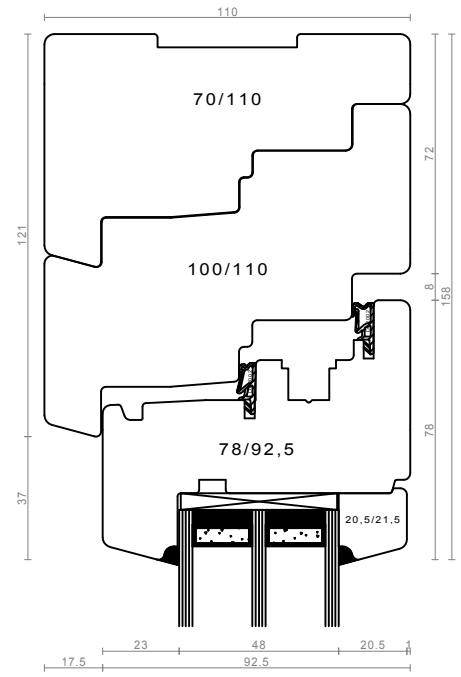

vložek v okvirju - pokončnik in zgornji prečnik

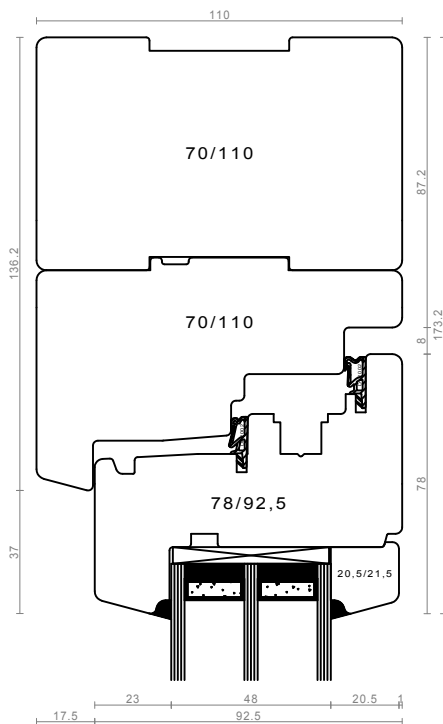

dodatni / naloženi kos - pokončnik in zgornji prečnik

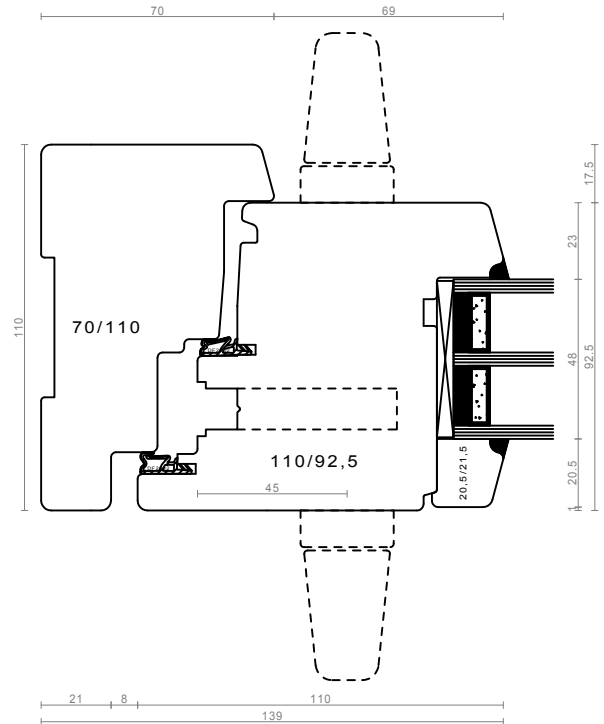

prehodna kljuka s cilindrom

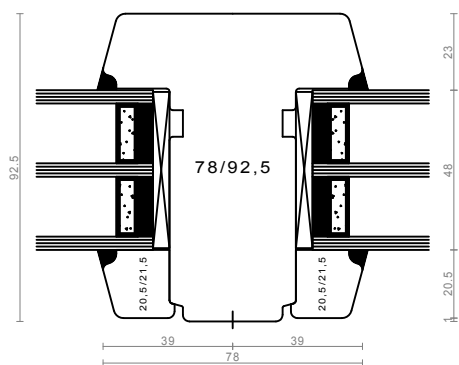

steklodeljivi križ / krilo - horizontalni / vertikalni

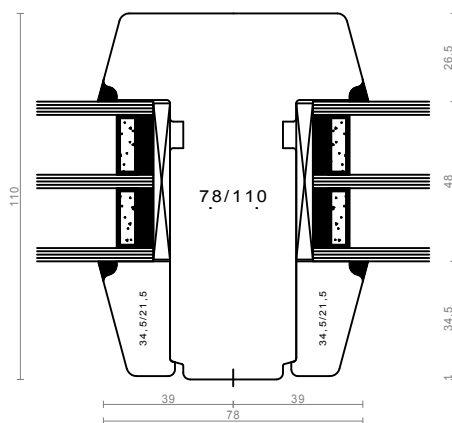

steklodeljivi križ / fiksno - horizontalni / vertikalni

nalepljeni križi - horizontalni / vertikalni

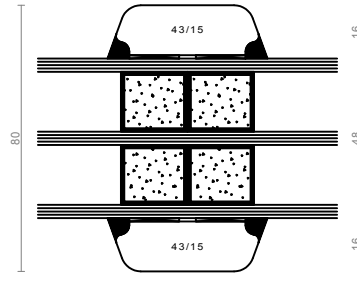
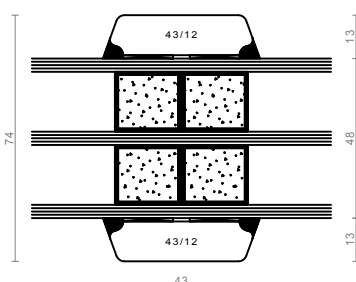
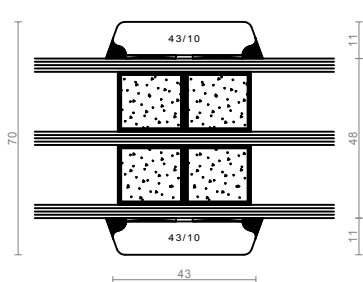
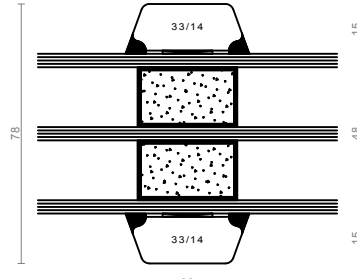
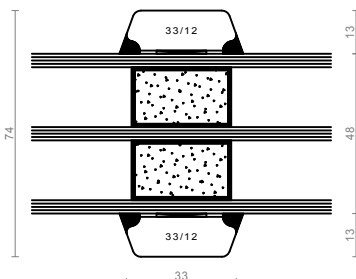
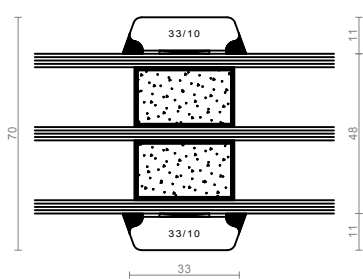
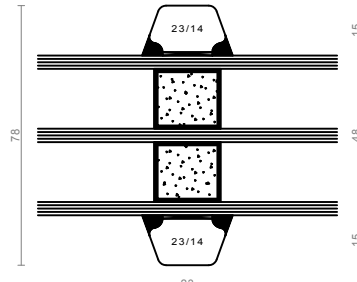
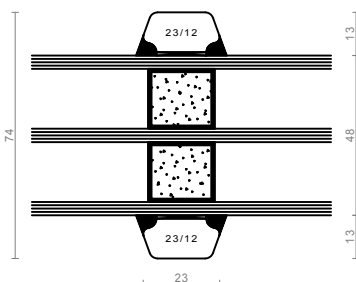
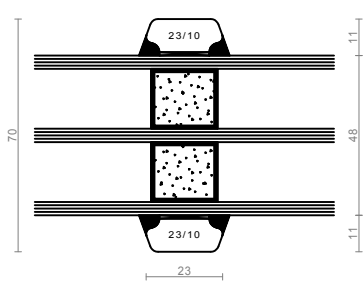

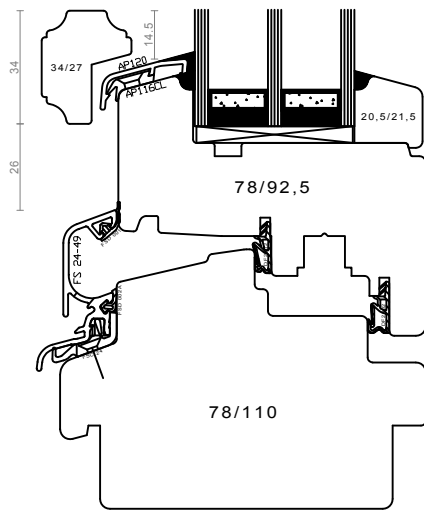
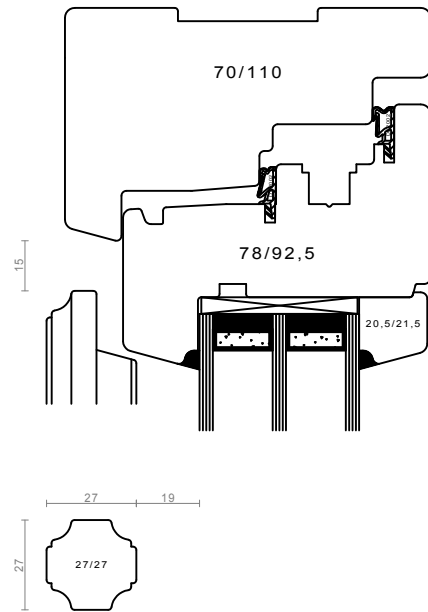
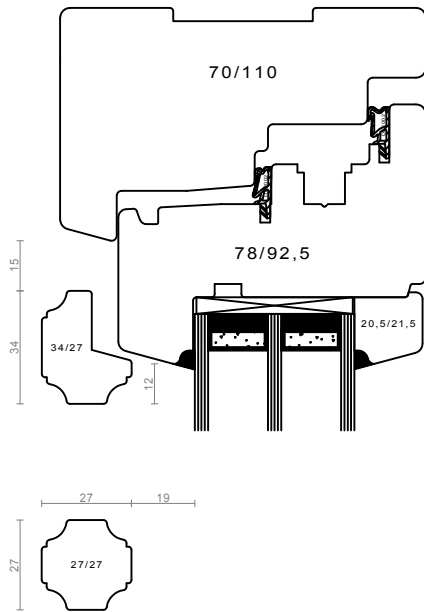

pripeti križi

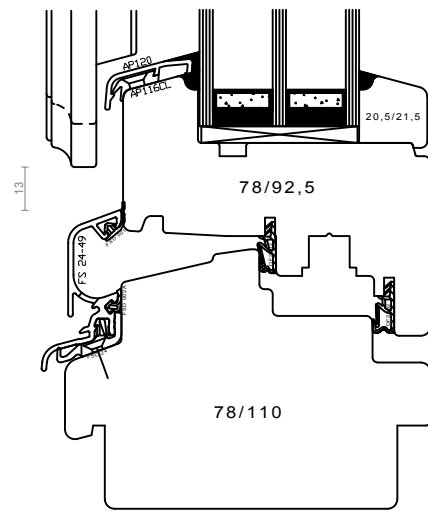

okvirni pripeti križi

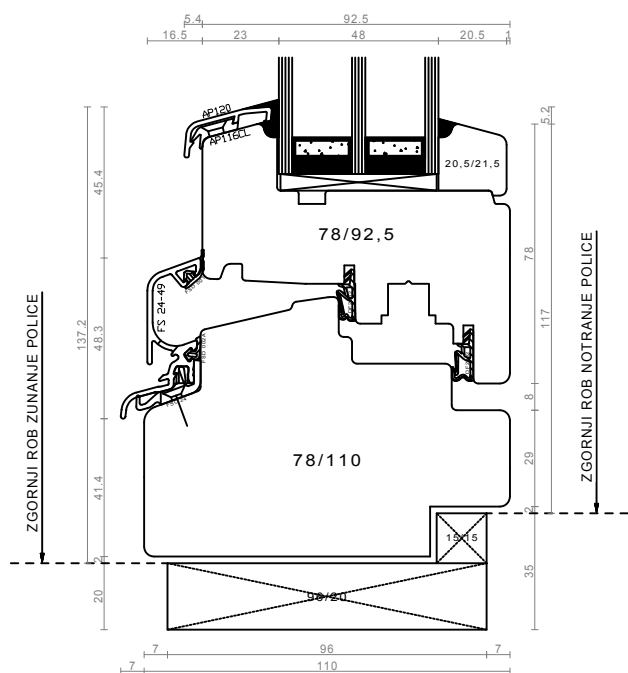

slepi podboj - spodnji prečnik - okno

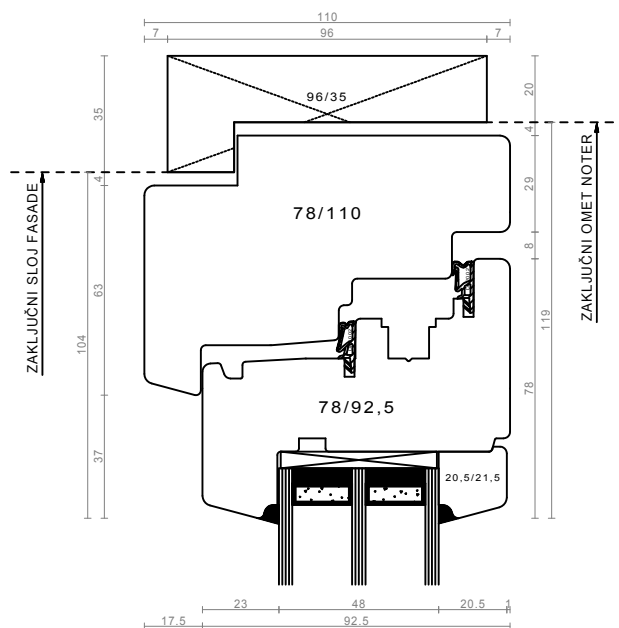

slepi podboj - pokončnik in zgornji prečnik

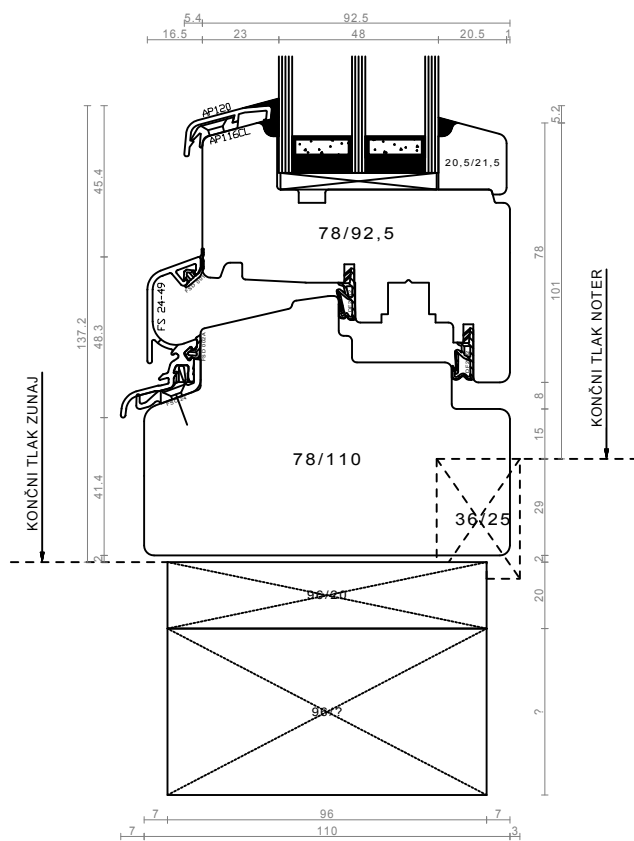

slepi podboj - spodnji prečnik - balkonska vrata

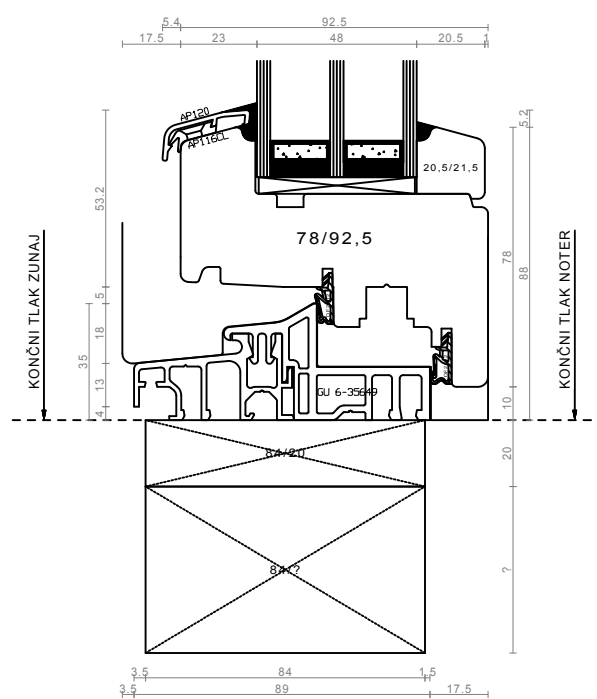

slepi podboj - spodnji prečnik - balkonska vrata / pohodni profil

